

EN GUIDE TO INSTALLATION AND USE

Cooking Hob

Dear valued customer,

To discover a De Dietrich product is to experience the range of unique emotions which only high-value items can produce.

The attraction is immediate, from the moment you set eyes on the product. The sheer quality of the design shines through thanks to the timeless style and outstanding finishes which make each appliance an elegant and refined little masterpiece in its own right, each in perfect harmony with the others.

Next, comes the irresistible urge to touch it. De Dietrich's design makes extensive use of robust and prestigious materials. The accent is placed firmly upon authenticity.

By combining state-of-the-art technology with top quality materials, De Dietrich produces beautifully crafted products to help you get the most from the culinary arts, a passion shared by all lovers of cooking and fine food.

We hope that you enjoy using this new appliance and we would love to receive your suggestions and to answer any questions you may have. Please feel free to contact our customer service department via our website.

To benefit from the many advantages offered by the brand, we recommend that you register your product at: www.de-dietrich.com.

Thank you for choosing a De Dietrich product.

De Dietrich

You can find a full range of information about the brand at www.de-dietrich.com

Visit the De Dietrich Gallery, 6 rue de la Pépinière (Paris eighth district)

Open from Tuesday to Saturday from 10 am to 7 pm

Customer service department: 0892 02 88 04

1 / INSTALLING YOUR APPLIANCE	
• Installation _____	4
• Connection _____	5
2 / USING YOUR APPLIANCE	
• The induction principle _____	6
• Description of your top _____	7
• Using a cooking zone _____	10
• Additional functions _____	10
Preheating	
Function Boil	
Delayed cooking	
Independent timer	
Elapsed time	
Power tracker	
Preselected power settings	
Child safety	
Clean lock	
• Safety features when operating _____	13
3 / MAINTAINING YOUR APPLIANCE _____	14
4 / SPECIAL MESSAGES, DIFFICULTIES _____	15
5 / AFTER-SALES SERVICE _____	16

We are constantly improving our products; for this reason we reserve the right to make all modifications to their technical, functional or aesthetic characteristics, originating from technical developments.



Warning

Before installing and using your appliance please read this installation and use the guide carefully - it will help you familiarise yourself very rapidly with its operation.

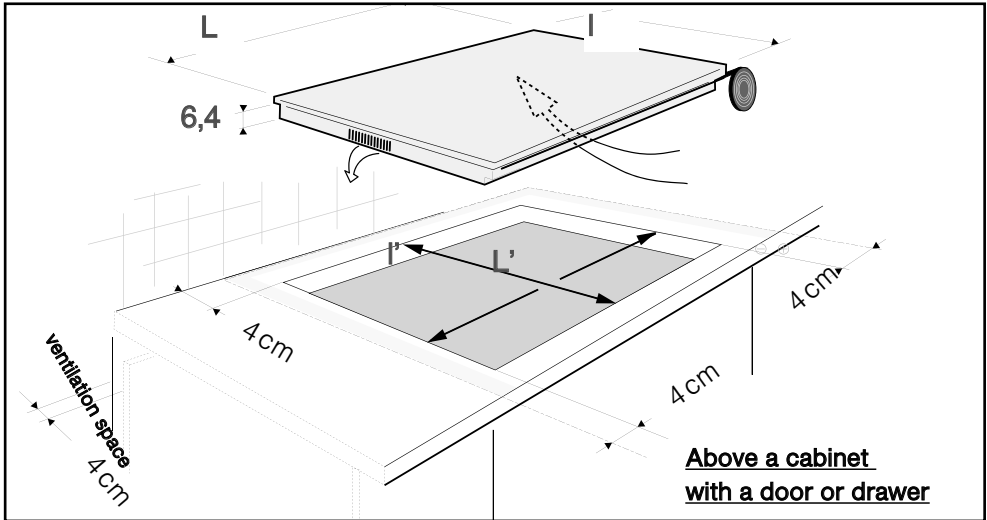

• CHOOSING THE POSITION

The distance between the edge of your appliance and the side and rear walls (or partitions) must be at least four centimetres (zone A).

Your appliance may be built in without any restriction. Check, however, that the air intake and outlet are free of obstruction (see "description of your appliance" chapter).

The building-in method opposite is recommended for use above an oven or a built-in appliance.

• BUILDING-IN

Follow the diagram above.

Glue the foam seal underneath the hole in the worktop, following the perimeter of the hole in the worktop, upon which your appliance will rest. This will ensure a good seal against the worktop.

Attach the clips to the hob (depending on the model).

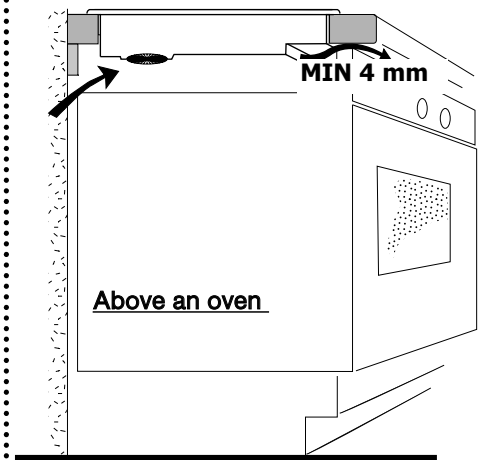

Tip

If your hob is located above your oven, the hob's thermal safety devices can impede the simultaneous use of the hob and the oven's pyrolysis program.

Your hob is equipped with an anti-overheating safety system.

This safety device can trigger, for example, when the hob is installed over an oven that is not sufficiently insulated. If this occurs, a series of small lines appears on the control panel. In such circumstances we recommend that you increase the hob's ventilation by creating an opening in the side of the cabinet, (8 x 5 cm), and/or installing an oven insulation kit available from the after-sales department.

Connection

These hobs must be connected to the mains using a socket in compliance with publication CEI 60083 or an all-pole circuit-breaker device in compliance with the installation rules in force.

When power is first supplied to your hob, or after an extended power cut, an indicator light will appear on the control panel. This information will disappear after 30 seconds.

• Hook-up of 220-240V ~

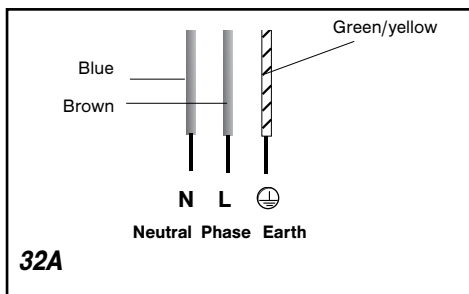

• 400V 2N ~ - 16A

Separate the 2 phase wires (L1 and L2) before connection.

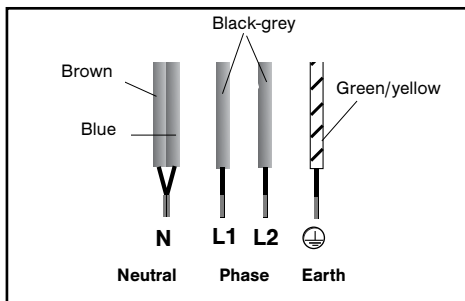

• 220-240V ~

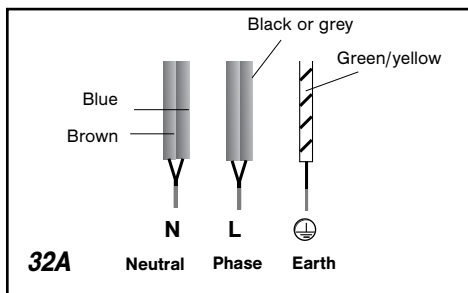

With hook-up of 400 V 2N three phase, verify that the neutral wire is properly connected.



Warning

If the cable is damaged it must be replaced by the manufacturer, its after-sales service or a person with a similar qualification to prevent danger.

We have designed this cooking hob for use by private individuals in their homes.

These cooking hobs are intended exclusively for cooking beverages and foodstuffs and do not contain any asbestos-based materials.

This appliance is not intended to be used by persons (including children) with reduced physical, sensory or mental abilities, or persons lacking experience or awareness, unless using it with the help of a person responsible for their safety, or under supervision and with prior instruction in its use. Children should be supervised to ensure that they do not play with the appliance.

• *The induction principle*

The principle of induction is based on a magnetic effect.

When you place your cookware on a cooking zone and you turn it on, the electronic circuits in your cooking hob produce “induced” currents in the bottom of the cookware which instantly raise its temperature. This heat is then transmitted to the food

To help you choose, a list of cookware is provided with this guide.

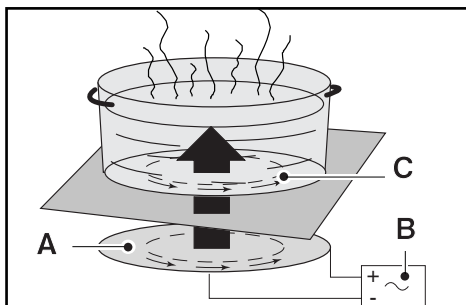

A - Induction plate

B - Electronic circuit

C - Induced currents

• *Cookware*

Most cookware is compatible with induction.

To verify that your cookware is suitable, place it on a heating area (16 or 23cm) on power 4.

- If the display remains on, your cookware is compatible.

- If the display flashes, your cookware cannot be used with induction cooking.

You can also use a magnet to test the cookware.

If a magnet “sticks” to the bottom of the cookware, it is compatible with induction.

Only glass, terra cotta, aluminium without a special finish on the bottom, copper and some non-magnetic stainless steels do not work with induction cooking. We recommend that you select cookware with a thick, flat bottom. When you buy your cookware, make sure that this logo is on the package; it assures you that it is compatible with induction cooking.

• *Choosing a cooking area*

Cooking area*	Diamètre of base of cookware
16 cm	10 18 cm
23 cm	12..... 26 cm
28 cm	12 32 cm
Gauche ou droite CONTINUUM	12.....20cm
Complete CONTINUUM	18....oval, fish kettle

Description of your top

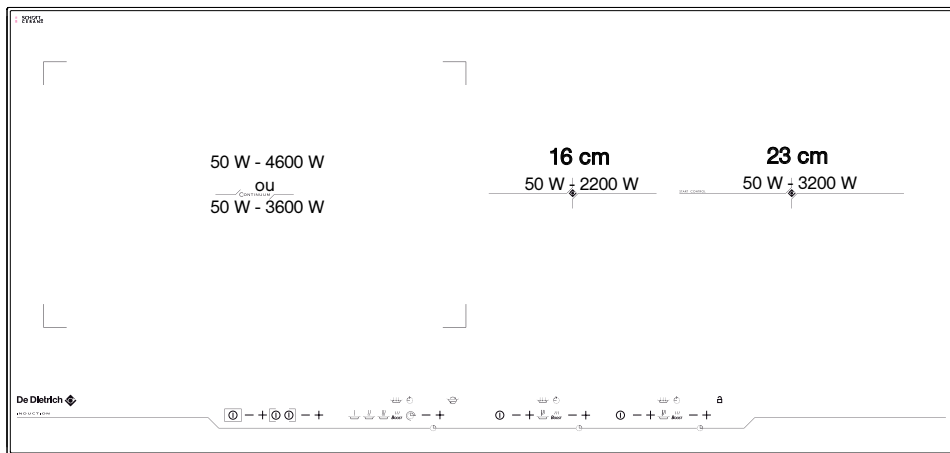

DTI1089V - DTI1089VE

Total dimensions (L x l) : 93 x 44

Recess cut-out (L' x l') : 90 x 41

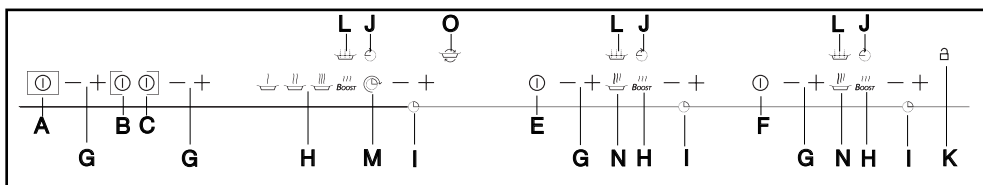

• Adjustment touch controls

Use these touchpads to select, turn on and turn off the cooking zones. When a zone is selected, you will see it light up, and you can adjust its settings.

- A** complete CONTINUUM zone
- B** left CONTINUUM zone
- C** right CONTINUUM zone
- E** zone 16 cm.
- F** zone 23 cm.

• Adjustment touch controls

These touchpads allow you to adjust power, timer, programmer... for each of the selected zones.

- G** adjusting the power
- H** preselecting the power
- I** adjusting the timer
- J** function *ELAPSED TIME*
- K** locking - unlocking - Clean lock
- L** function *BOIL*
- M** Selecting cooking zone for use with timer
- N** Multiple power level preset
- O** function *SWITCH*

Description of your top

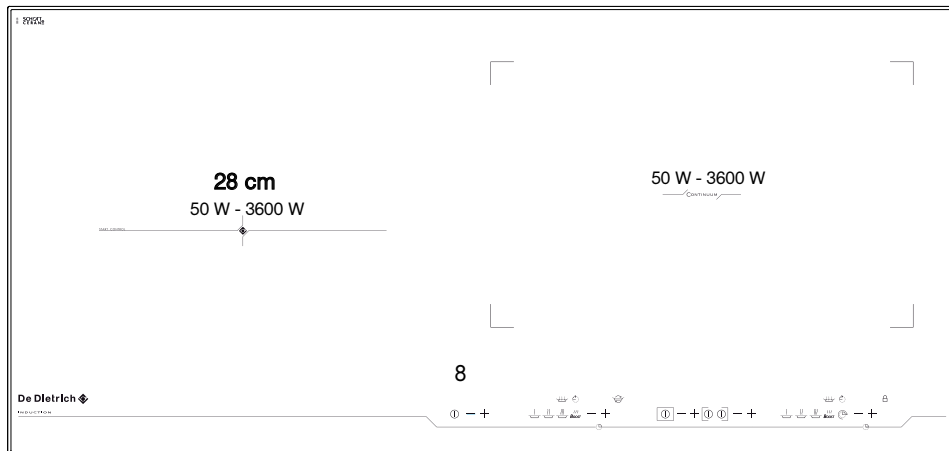

DTI1169VE

Total dimensions (L x I) : 93 x 44

Recess cut-out (L' x I') : 90 x 41

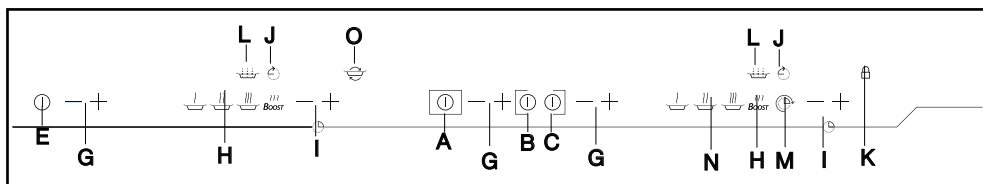

• Adjustment touch controls

Use these touchpads to select, turn on and turn off the cooking zones. When a zone is selected, you will see it light up, and you can adjust its settings.

- A** complete CONTINUUM zone
- B** left CONTINUUM zone
- C** right CONTINUUM zone
- E** zone 28 cm.

• Adjustment touch controls

These touchpads allow you to adjust power, timer, programmer... for each of the selected zones.

- G** adjusting the power
- H** preselecting the power
- I** adjusting the timer
- J** function *ELAPSED TIME*
- K** locking - unlocking - Clean lock
- L** function *BOIL*
- M** Selecting cooking zone for use with timer
- N** Multiple power level preset
- O** Function *SWITCH*

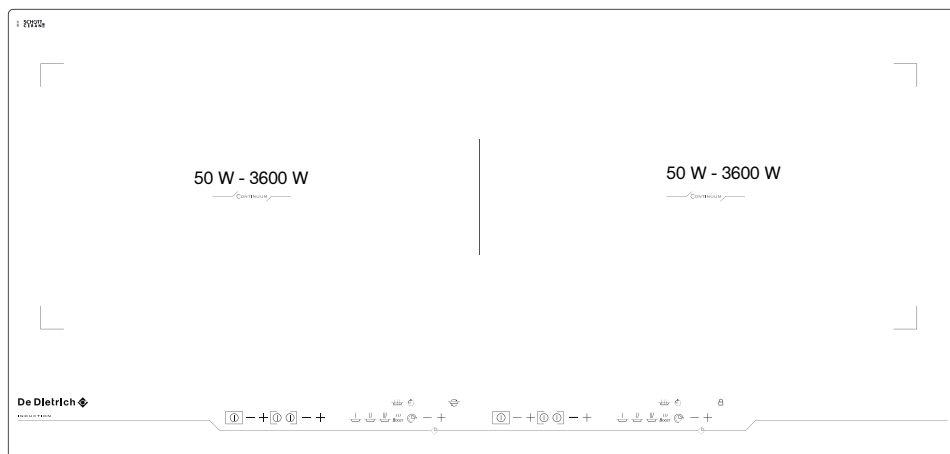
Description of your top

DTI1199GE

Total dimensions (L x l) : 93 x 44

Recess cut-out (L' x l') : 90 x 41

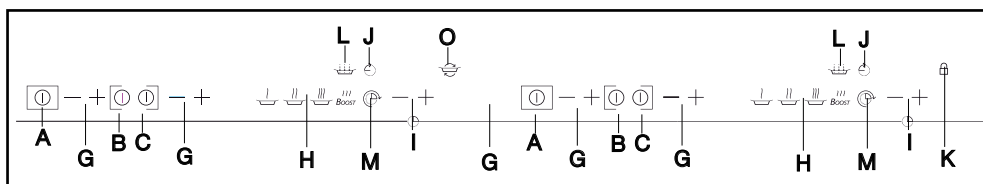
**• Adjustment touch controls**

Use these touchpads to select, turn on and turn off the cooking zones. When a zone is selected, you will see it light up, and you can adjust its settings.

- A** complete CONTINUUM zone
- B** left CONTINUUM zone
- C** right CONTINUUM zone

• Adjustment touch controls

These touchpads allow you to adjust power, timer, programmer... for each of the selected zones.

- G** adjusting the power
- H** preselecting the power
- I** adjusting the timer
- J** function *ELAPSED TIME*
- K** locking - unlocking - Clean lock
- L** function *BOIL*
- M** Selecting cooking zone for use with timer
- N** Multiple power level preset
- O** Function *SWITCH*

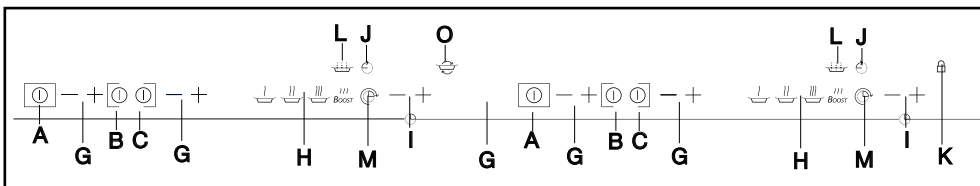

Using a cooking zone

Adjusting the power level:

- Place your cookware on the cooking zone and press the corresponding button **A**, **B**, **C**, **E** or **F**. A beep and a light will confirm your selection.
- Adjust the power with the buttons **G** (+/- that are closest to the selected zone), **H** (preset 4/8/15) or **N**.
- Pressing the **N**  button several times allows you to access preselected power levels (4, 8 or 15).

Switching off a cooking zone

- Hold your finger down on the select button

Adjusting the timer:

- For cook zones A, B and C, select a zone by pressing **M**, (choose zone [,], []) then press **I**. The displayed shows the time for the cooking zone with the shortest time.
- Adjust the timer using button **I**.
- When the cooking is finished, "0" is displayed and a beep sounds. Press on the selector button for the zone to delete this information.

N.B.:

- The first touch on **I** "-" directly selects 99 minutes.
- Simultaneous pressing **I** "+" and "-" cancels the timing in progress.
- If you do not make a selection or if there is no cookware the selected zone turns off after a few moments.
- For zones **A**, **B**, **C** a "•" is displayed to indicate that the timer is in use.
- After the pre-heating stage, your hob displays the cooking power.

Additional functions

• Preheating

This function allows a higher temperature to be reached more rapidly, followed by an automatic return to cooking power.

- Select a cooking zone

- Turn on preheating with the button **G** "-", **HU** is displayed on your hob.
- Pre-adjust the cooking power with **G** buttons (higher than 7). A beep will confirm your adjustment after a few moments. Cooking starts.
- During the pre-heating stage, **HU** and the cooking power display alternately.

N.B.:

- The pre-heating time is calculated automatically by your hob depending on the cooking power level chosen.
- When **HU** is displayed, if you do not adjust the cooking power, the zone turns itself off after a few moments.

• BOIL

This function allows water to be boiled and kept at boiling point to cook any food that requires boiling.

- Give a short press on button **L**. You will hear a short beep. "2l" (2 litres) is displayed as the default.
 - Adjust the volume of water to between 1 and 6 litres, using the + and - buttons (**G**). The quantities of water are 1l, 2l, 3l, 4l, 5l and 6litres.
 - Give a short press on button **L** to confirm the selection. A short beep sounds and the  is displayed.
- Once the water has boiled, a series of beeps is heard.
- add the food (pasta, rice etc.). Give a short press on button **L**. Power 12 or 13 and 1 min is displayed by default.

Adjust the time, using the buttons **I**. If you wish, you may alter the power via the buttons **G**.

The settings are confirmed automatically after a few seconds or by pressing button **L**. A short beep sounds.

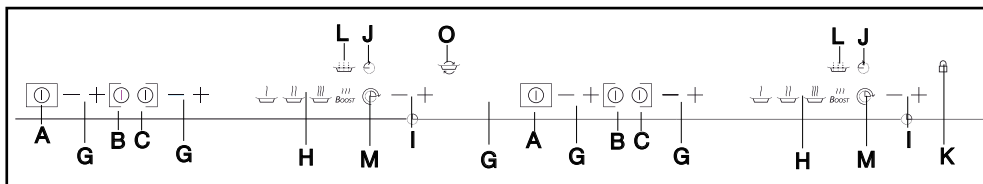

NOTE: It is important that the water temperature is neither too hot nor too cold when cooking begins, as this could affect the final result.

This function may be used on all cooking zones at the same time.

Do not use cast iron cookware.

Do not use a lid.

Do not use salt.

• *Delayed cooking (except DT1199GE)*

This function allows you to delay your cooking (available only for the START CONTROL zone).

Program delayed cooking in 6 steps:

- 1 - Select the cooking zone dedicated to this function.
- 2 - Press simultaneously on touchpads I “+” and “-” to adjust the current time of your hob. When the numbers flash, you can adjust the hour with the touchpad J, then wait a few moments. If the hour displayed is correct, wait a few moments. The display will stop flashing and a beep will confirm the setting.
- 3 - Set the end of cooking time by pressing on touchpad I. Wait a few moments. A beep will confirm your setting.
- 4 - Set the duration of cooking time by pressing on touchpad I. Wait a few moments. A beep will confirm your setting.
- 5 - Set the power of your cooking by pressing on touchpad G, 4 is displayed by default (maximum 6). Wait a few moments. A beep will confirm your setting and **SC** is displayed on your hob.
- 6 - After a few moments, **SC** goes out and a flashing point appears to indicate that delayed cooking has been engaged.

• *Independent timer*

This function allows you to time an event, without cooking.

- Select a cooking zone you are not using or the zone CONTINUM.

- Set the time with touchpad I or M for the zone CONTINUM. A “t” flashes in the display.
- At the end of your adjustment “t” becomes fixed and the count begins.

Note:

You can stop a count in progress by keeping your finger on the touchpad of the selection on the display.

• *Elapsed time*

This function displays the time elapsed since the last power setting adjustment on a chosen zone.

To use this function, press the J button. The elapsed time flashes on the timer display of the selected zone.

If you want cooking to end in a specific period, press button J then, in 5 seconds, press “+” on the timer to increase the cooking time that you wish to set. The time display becomes steady for 3 seconds then the remaining time is displayed. There is a beep to confirm your choice.

This function exists with or without the timer function.

Note: If a time is displayed on the timer, this time cannot be changed during the 5 seconds after pressing the J button. Once these 5 seconds have elapsed, you may change your cooking time.

• **Switch**

This function lets you move a pan from one zone to another, keeping the original settings (power level and time).

- 1 - Press on button **O**, and a short beep sounds then the pan is moved to the new zone.
- 2 - Press on button **H** again; the information is displayed on the new zone. The original cooking zone switches off when the settings are displayed on the new zone.
 - If there is no pan before button **O** is pressed, a long beep sounds and the function is cancelled.
 - If button **O** is pressed and more than one pan is moved, the function is cancelled and **NO** appears in the display.

If you move a pan from a complete cooking zone to another complete cooking zone, the function is cancelled and **NO** appears in the display.

If the "Power tracker" function activates more than one new zone, the function is cancelled and **NO** appears in the display.

• **Preselected power settings**

This function allows you to modify the power levels defined in the preselections (except for the boost).

- Your cooking hob must be turned off.
- Select the preselection **H** to modify, by keeping your finger on it.
- Set the new power setting by pressing on touchpad **G**.
- A beep will confirm your action after a few moments.

N.B.:

The power levels must be between:

- 1 and 5 for the first touch.
- 6 and 10 for the second.
- 11 and 15 for the third.

• **Child safety**

This function allows you to lock your hob when it is shut off or when it is cooking.

To lock:

- Keep your finger on touchpad **K**. A beep sounds and an indicator appears. The indicator will go out automatically after a few moments.

To unlock:

- Keep your finger on touchpad **K**. A beep sounds and the indicator goes out.

Note:

- In locked mode, any action will produce a key symbol on the display. You must unlock your hob before using it.
- If you activate the lock while cooking, the stop display will be prioritised on the lock.

• **Clean lock**

This function allows you to temporarily lock your hob while cleaning.

To activate Clean lock:

- Your cooking hob must be turned off.
- Briefly press touchpad **K**. A beep sounds and an indicator appears.
- After a predefined time, the lock will automatically disengage. A beep sounds and the indicator goes out.



As shown in this logo, the materials used to package this appliance are not recyclable. Recycle them and play a role in protecting the environment by depositing them in municipal containers provided for this purpose.

Recycling of the appliances organised by your manufacturer will thus be undertaken in optimum conditions, in accordance with European directive 2002/96/CE relating to electrical and electronic equipment waste. Contact your local authority or retailer for how to have used appliances collected or collection points.

Safety when operating

• Residual heat

After a long cooking period, the zone used can remain hot for several minutes. An “H” flashes during this period. Do not put your hand on the zone.

• Temperature limiter

Each cooking zone is equipped with a safety sensor that constantly monitors the temperature of the bottom of the cookware. If you leave empty cookware on a zone which is turned on, it will automatically limit the power in order to prevent damage to the cookware or hob.

• Protection against overflows

In case of overflow, or of a metallic object or wet cloth placed on the control areas, the hob turns itself off, the displays light up and a beep sounds. Clean the hob or remove the object, then begin cooking again.

• For users with heart pacemakers and active implants.

The functioning of the hob conforms to current electromagnetic interference standards and thus is in total compliance with legal requirements (89/336/EEC directives).

In order to avoid interference between your cooking hob and a pacemaker, your pacemaker must be designed and programmed in compliance with the regulations that apply to it.

As we can guarantee the compliance only of our own products, we strongly recommend that you refer to the maker of your device or to your doctor to avoid possible incompatibilities.

• Auto-Stop system

If you forget cooking is in progress, after a predefined time, this safety function will automatically turn off your hob (from 1 to 10 hours depending on the power setting). “AS” displays and a beep sounds after about 2 minutes. Press on the main selector to delete this information. A beep will confirm your setting.

• “Small Items” safety

If you place a small object on the area (a ring, a fork, etc), the hob will detect it and not deliver any power. The power display flashes.

Note:

However, several small objects at the same time on a zone could be identified as cookware. In that case, power will be delivered by the hob.



It is recommended that you avoid placing metal objects such as knives, forks, spoons and lids on the cooking surface, as they may become hot.

Preserve your appliance

The vitroceramic glass surface is highly resistant, but not unbreakable. Here are some recommendations for increasing its lifetime:

- Avoid banging or clattering the cookware.
- Avoid putting heating covers on the hob. A suction effect may damage the vitroceramic surface.
- Do not use cookware with bottoms that are rough or dented.
- Do not use your cooking hob as a work surface.
- Never use aluminium foil or paper or aluminium scrubber to clean it. The aluminium melts and damages the top.
- Never use a steam cleaner to clean your hob.

- Never directly reheat a tin can. It will have a risk of exploding.

Aesthetic faults, as a result of mistreatment of your hob and which do not entail a lack of function, are not covered by our guarantee.

And for the safety of your kitchen, do not place cleaning items or inflammable objects or products in the kitchen furniture underneath your cooking hob.

Maintaining your appliance

TYPES OF STAINS/SPOTS	USE	WHAT TO DO?
Light.	Cleaning sponges	Thoroughly moisten the zone to be cleaned with hot water, then wipe off.
Accumulation of baked-on stains/dirt. Sugar spills, melted plastics.	Cleaning sponges Scraper for glass.	Thoroughly moisten the zone to be cleaned with hot water. Use a scraper for glass to remove the large bits, follow with the rough side of a disinfectant sponge, and then wipe off.
Rings and hard water residue.	White vinegar.	Apply warm white vinegar to the stain, let stand, then wipe with a soft cloth.
Shiny metal colourings. Weekly maintenance.	Special vitroceramic glass product.	Apply a cleaning agent for vitroceramic glass (preferable one with silicon for its protective properties) to the surface.



cream



cleaning sponge
special for delicate crockery



powder





abrasive sponge



• On first use

	<i>POSSIBLE CAUSES:</i>	<i>WHAT SHOULD YOU DO?</i>
A special lamp appears.	Working normally.	Nothing, the light disappears after 30 seconds.
Your installation blows a fuse.	The electrical connection of your hob is incorrect.	Check that it is set up properly. See the “Electrical Connection” section.
Only one side works.		
The hob produces an odour during the first cooking sessions.	New appliance.	Nothing. The smell will disappear after several uses.

• On switching on

<i>YOU OBSERVE THAT:</i>	<i>POSSIBLE CAUSES:</i>	<i>WHAT SHOULD YOU DO?</i>
The hob does not operate and the indicator lights on the control panel do not light up.	The machine is not connected to the power source. The power source or connection is defective.	Inspect the electrical circuit breaker and fuses.
The hob is not working and another message is displayed.	The electronic board is functioning poorly.	Call the After-Sales Service Department.
The hob does not function, the information   is displayed.	The hob is locked	See chapter on using the child safety system

• While in use

<i>YOU OBSERVE THAT:</i>	<i>POSSIBLE CAUSES:</i>	<i>WHAT SHOULD YOU DO?</i>
The hob has stopped operating and is beeping approximately every 10 seconds and a  or F7 is displayed.	There was an overflow or an object is in contact with the control panel.	Clean the hob or remove the object, then begin cooking again.
A series of small  or F7 is displayed.	The electronic boards heated up.	See “Inserting” section.
After turning on a heating zone, the indicator lights on the control panel continue to flash.	The cookware used is not suitable for induction or is less than 12 cm in diameter (10 cm on a 16 cm area).	See section on cookware for induction.
The saucepans make noise during cooking. Your hob makes a clicking sound during cooking.	This is normal with some types of cookware. This is caused by the transfer of energy from the hob to the cookware.	Nothing. There is no risk, neither to your hob nor to your cookware.
The fan continues to function a few minutes after your hob is turned off.	Cooling of the electronic components. Working normally.	Nothing.
After turning on a heating zone, the indicator lights on the control panel remain steady but the cookware is not heated.	The cookware used is not suitable for use with induction.	See section on cookware for induction.

Any maintenance on your equipment should be undertaken by:

- either your dealer,
- or another qualified mechanic who is an authorized agent for the brand appliances.

When making an appointment, state the full reference of your equipment (model, type and serial number). This information appears on the manufacturer's nameplate attached to your equipment.

For UK after sales service information please contact:-

www.dedietrich.co.uk

De Dietrich UK office – tel: 01256 308000



In case of breakage, cracks or even light fissures in the vitroc ceramic glass, take out the fuses or turn off the circuit breaker for your hob to avoid the risk of electrical shock.

Contact the After-Sales Service Department.

DE DIETRICH COOKING PRODUCT WARRANTY

1. Subject to the "Statement of Standard Warranty Conditions" this product is covered by the following Warranty.
TWO (2) YEARS WARRANTY from date of purchase, covering all parts and labour.
2. The appliance is warranted under normal single family domestic installation and use, as set out in the instruction manual, against manufacturing defects for the Warranty periods shown above.
3. Should service be required under this Warranty, the purchaser should contact an approved DE DIETRICH Service Provider during their normal business hours.
4. At no time does DE DIETRICH/MEA have liability for any freight or transportation costs or for any damage during transit or for any consequence of failure of this appliance outside of the normal service area, unless such limitation of liability is prohibited by statute.
5. This Warranty excludes replacement of parts required due to normal wear and tear including light globes.
6. This Warranty only applies, provided the appliance has been used in accordance with the manufacturer's instructions and provided an accident, misuse, neglect or abuse has not damaged the appliance.
7. None of the above Warranties purport to exclude, restrict or modify either the application or the exercise of a right conferred by any applicable Statute.
8. Please complete the details below, which should be retained for future reference along with your proof of purchase:

Date of Purchase:

Model No:

Serial No:

MEA0702

STATEMENT OF STANDARD WARRANTY CONDITIONS

1. The Warranty only applies provided that the appliance has been used in accordance with the manufacturer's instructions and provided that the appliance has not been damaged by an accident, misuse, neglect or abuse of any person other than the manufacturer or DE DIETRICH/Major Electrical Appliances ("MEA") or from faulty installation, mis-adjustment or tampering by unauthorised persons.
2. When a service inspection reveals the alleged fault or faults are caused by incorrect operation, contrary to the instruction manual, and otherwise the appliance is in good order and working condition, the purchaser shall be liable for a service fee charged by DE DIETRICH/MEA or one of its' Service Providers.
3. If the appliance is used in Commercial Applications or for Rental purposes, a separate warranty of Twelve (12) months covering all parts with Three (3) months on the labour will apply.
4. Subject to the provisions of any applicable statute this Warranty applies to the original retail purchaser only and is not transferable.
5. Subject to the provisions of any applicable statute, at no time does DE DIETRICH/MEA have liability for freight, transport or travel costs outside normal service areas.
6. None of the above Warranties purport to exclude, restrict or modify either the application or the exercise of a right conferred by any applicable statute.
7. Subject to any Warranties implied by statute, at no time will DE DIETRICH/MEA or its' Service Providers be liable for any economic loss consequent upon the failure of the appliance.
8. This Warranty is only valid for major appliances imported and distributed by DE DIETRICH/MEA, purchased and used in Australia.