

## Induction Hob

DTi705

De Dietrich 



Dear Customer,

Thank you for buying a DE DIETRICH hob.

Our research teams have designed a new generation of kitchen appliances. As a result of our unique expertise, we have produced a range of goods whose quality, design and technical advance are unsurpassed.

You will find that the clean lines and modern look of your De Dietrich hob blends in perfectly with your kitchen décor. It is easy to use and performs to a high standard.

De Dietrich also makes a range of products that will enhance your kitchen such as hobs, extractor hoods, built-in dishwashers and refrigerators. There are models to complement your new De Dietrich hob.

Of course, we make every effort to ensure that our products meet all your requirements, and our Customer Service department is at your disposal, to answer all your questions and to listen to all your suggestions (see back cover of manual).

De Dietrich is certain that by setting new standards of excellence by which comparisons can be made, customers will find that De Dietrich appliances offer a better and more exciting way of living.

DE DIETRICH.

[dedietrich.co.uk](http://dedietrich.co.uk)

We are constantly improving our products; for this reason we reserve the right to make all modifications to their technical, functional or aesthetic characteristics, originating from technical developments.



This appliance is not intended for use by persons (including children) with reduced physical sensory or mental capabilities, or lack of experience and knowledge, unless they have been given supervision or instruction concerning use by a person responsible for their safety.

Children should be supervised to ensure that they do not play with the appliance



**WARNING**

This product is not for use in the USA.

Before installing and using this appliance please read the installation guide section of this booklet fully. This guide will help you to quickly familiarise you with all the features of the appliance.

- 1/ Description of your appliance
- 2/ Overview / working principle
- 3/ Quick start guide
- 4/ Product / Safety features explained
- 7/ Cleaning and maintaining your appliance
- 8/ Installation guide
- 11/ Help Guide

## DTi705W

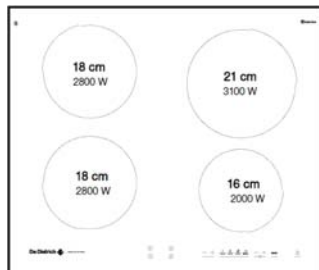

### DTi705W

Total dimensions (L x l) (L x l) -  
DTi705W/X: 65cm x 52cm

Recess cut-out (L' x l')  
DTi705W: 56cm x 49cm

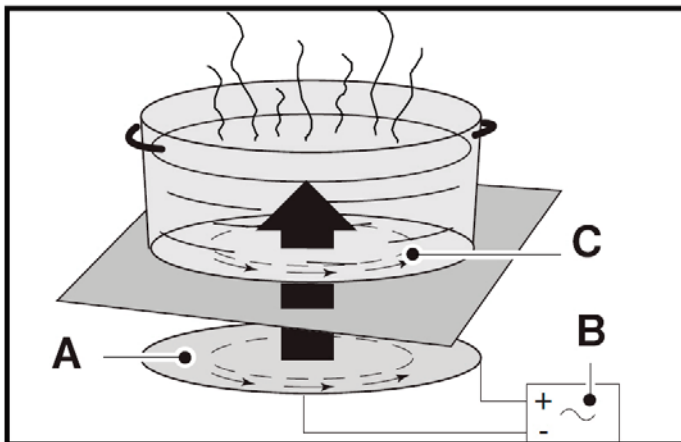

- A Induction coils
- B Glass insulating hob top
- C Ferrous pan base

## The induction principle

The principle of induction is based on a magnetic effect. When you place your cookware on a cooking zone and you turn it on, the electronic circuits in your cooking hob produce “induced” currents in the bottom of the cookware which instantly raise its temperature. This heat is then transmitted to the food.

In order for an induction hob to operate the cookware must have a ferrous base (containing Iron). A simple rule is if a magnet sticks to the base of your pan then it should be suitable for use on induction hobs.

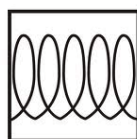

Induction

When you buy your cookware, make sure that one of these logos are on the package; it assures you that it is compatible with induction cooking.

## Cookware

To verify that your cookware is suitable, place it on a heating area on power 4. - If the display remains on, your cookware is compatible.

- If the display flashes, your cookware cannot be used with induction cooking.

You can also use a magnet to test the cookware. If a magnet “sticks” to the bottom of the cookware, it is compatible with induction. Glass, terra cotta, aluminium without a special finish on the bottom, copper and some non-magnetic stainless steels do not work with induction cooking.

We recommend that you select cookware with a thick, flat bottom.

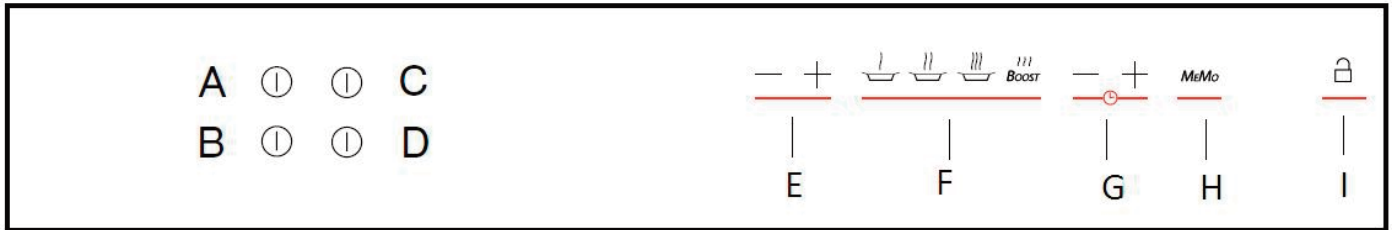

## Controls Table

		E	Power "+" and "-" controls
		F	Power pre-set controls
A	Rear Left Cooking Zone Selector	G	Timer "+" and "-" Controls
B	Front Left Cooking Zone Selector	H	MeMo control
C	Rear right Cooking Zone Selector	I	Lock control
D	Front Right Cooking Zone Selector		

## Quick Start Guide

Prior to using you appliance you need to ensure the appliance has been installed in accordance with the installation instructions within this guide. Particular attention should be paid to the ventilation requirements as this could affect the performance of the appliance as well as the long term reliability.

### Operation

Care should be taken to ensure that the pan / pans being used cover a minimum of 80% of the cooking zone.

Place the pan on the zone you wish to use and select the zone on the control panel using the selector controls "A" "B" "C" or "D".

Select either a pre-set power level "F" or use the "+" or "-" controls "E" to determine the desired power level. If you wish to control more than one pan these should be selected in turn, noting the controls apply the power settings to the last zone selected. This is shown by an indicator light adjacent to the zone selector controls.

 You may notice a clicking noise when either using multiple zones or a single zone on low power settings (below level 7). This is normal and should not be considered a fault; it is the electronics of the appliance regulating the power delivery to the zones. You may notice a corresponding reduction of the bubbles in the base of the pans on the hob, again this is normal.

 **Power sharing**  
The machine is manufactured with the electronics controlling the cooking zones in pairs normally one pair for the left zones and one for the right zones (left and rear centre, and right and front centre on the DTI718). The power delivered by the independent electronics is split between these two zones. If "boost" is selected on one zone the power is reduced on the other to ensure the maximum connected load is not breached. This is not a fault with the appliance.

From time to time you may wish to select "Boost" on more than one zone; this can be done from selecting one on the right of the appliance and one on the left.

 **Suitable cookware**  
If the display on the appliance flashes when set, this is an indication that either there is no pan on the zone or, an unsuitable pan is being used. Please refer to the pan guide in the description section of this guide for further details.

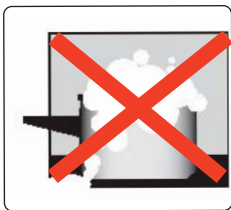

**Protection against overflows.** In case of overflow, or of a metallic object or wet cloth placed on the control areas, the hob turns itself off, the displays light up and a beep sounds. Clean the hob or remove the object, then begin cooking again.



**Temperature limiter.** Each cooking zone is equipped with a safety sensor that constantly monitors the temperature of the bottom of the cookware. If you leave empty cookware on a zone which is turned on, it will automatically limit the power in order to prevent damage to the cookware or hob.



**Residual heat.** After a long cooking period, the zone used can remain hot for several minutes. An "H" flashes during this period. Do not put your hand on the zone.



**Auto-Stop system.** If you forget cooking is in progress, after a predefined time, this safety function will automatically turn off your hob (from 1 to 10 hours depending on the power setting). "AS" displays and a beep sounds after about 2 minutes. Press on the main selector to delete this information. A beep will confirm your setting.

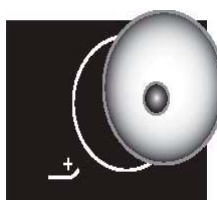

**Automatic Pan Detection:** detects when a suitable pan is placed on the cooking zone and so eliminates the possibility of the hob being activated accidentally by a non-suitable object.



**"Small Items" safety.** By placing a small object on the area (a ring, a fork, etc), the hob will detect it and not deliver any power. The power display flashes. Note: However, several small objects at the same time on a zone could be identified as cookware. In that case, power will be delivered by the hob. Do not place any utensils (spoons, forks, covers, etc) on the cooking zone being used. They will heat up in the same way as cookware: Risk of combustion.



**Child Lock:** for added peace of mind, the child lock can be manually activated to prevent accidental start-up. To activate the lock pres the “I” key and hold until a beep is sounded and an indicator appears. To de-activate hold the “I” key until the indicator goes out and a beep sounds.



**Control Lock:** can be activated to lock the control panel during the cooking process. This will lock the controls set on the cooking zones but will allow the stop key to function. This is activated in / deactivated in the same way as the child lock.



**Clean lock**  
This function allows you to temporarily lock your hob while cleaning. To activate Clean lock your cooking hob must be turned off.  
- Briefly press touchpad “I”. A beep sounds and an indicator appears.  
- After a predefined time, the lock will automatically disengage. A beep sounds and the indicator goes out.



**Electronic Power Monitor:** prevents power surge and de-surge in the event of electrical interference without loss of performance to the hob.



**MEMO** - Memorisation of a cooking  
This function allows the hob to memorise and reproduce an entire cooking cycle.  
NOTES -

- In order to ensure accurate reproduction of the initial cooking the same cookware should be used.
- Each time this feature is used it erases any previous settings.
- Preheating cannot be used with the MeMo.

- If the hob is switched off, pressing the “MeMo” button will display any programmed settings

To use **MeMo**:

- Select a cooking zone.
- Keep your finger on the touchpad “H”, until the indicator is illuminated,
- Adjust the power during cooking in the normal way with touch pads “E” or “F” this can be adjusted up to five times in any cooking cycle, allowing a minimum of 10 seconds for each power level change to register (if the number of settings exceeds 5 “NO” will be displayed on the display)

To save the setting at the end of cooking press the touchpad of the corresponding zone.

To reproduce the cooking the same zone used in the initial cooking must be selected followed by “MeMo” (“NO” will be displayed if a different zone is selected). The programmed power levels will be displayed in sequence followed by the start of cooking.

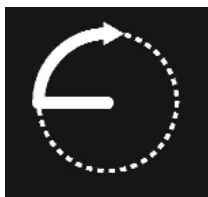

## Timer Functions

Each zone of the appliance can be controlled by using the timer function to turn off the zone after a set period of time.

Select the zone required and adjust the power as required. Press the timer controls "G" and using the "+" or "-" keys select the cooking time required. The appliance will now count down the time and turn off as required. When the time remaining is less than 1 minute the display will indicate seconds remaining. At the end of the time a beep will indicate the end of cooking.



## Independent timer

The timer function can be used as an independent timer if required. Select a zone not in use and select the Timer control "t" will flash. Using the timer keys "G" select the time required "t" will become fixed and the countdown will begin.

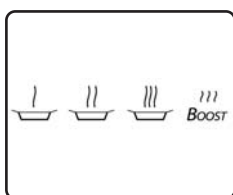

## Adjusting the factory preset levels

With the hob turned off, press and hold the preset to be adjusted, while pressing the preset adjust to the required power level.

Preset one can be adjusted between level 1-5 preset two between 6-10 preset three between 11-15

No adjustment can be made to the boost function.

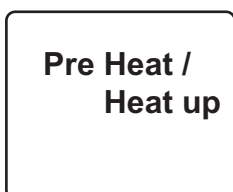

## Pre-heat / Heat up

This Function will preheat the contents of the pan to boiling temperature before reducing to your selected power.

To select the function turn on the required zone then press the "-" on the power selection keys, "HU" is shown on the display, Select the power level to be maintained after the initial heat up ( this must be level 7 or above ). During the pre-heat phase the display will alternate between the selected power level and "HU", once the preheating is complete the display will revert to the power level only. This feature can be used in conjunction with the timer functions. For example you can set the appliance to preheat a pan of pasta to a boil reduce the pan to a simmer then time the entire cooking phase to ensure perfect results every time.

## Preserve your appliance

The vitroceramic glass surface is highly resistant, but not unbreakable. Here are some recommendations for increasing its lifetime:

- Avoid banging or clattering the cookware.
- Avoid putting heating covers on the hob. A suction effect may damage the vitroceramic surface.
- Do not use cookware with bottoms that are rough or dented.
- Do not use your cooking hob as a work surface.
- Never use aluminium foil or paper or aluminium scrubber to clean it. The aluminium melts and damages the top.
- Never use a steam cleaner to clean your hob.
- Never directly reheat a tin can. It will have a risk of exploding.

For the safety of your kitchen, do not place cleaning items or inflammable objects or cleaning products in the kitchen furniture underneath your cooking hob.

## TYPES OF STAINS/SPOTS

Light accumulation of baked-on stains/dirt.

Sugar spills, melted plastics.

Rings and hard water residue.

Shiny metal

Aesthetic faults to the hob top which does not entail a lack of function, are not covered by our guarantee. Full terms of the guarantee are available at [www.dedietrich.co.uk](http://www.dedietrich.co.uk).

## Maintaining your appliance

TYPES OF STAINS/SPOTS	USE	WHAT TO DO?
Light.	Cleaning sponges	Thoroughly moisten the zone to be cleaned with hot water, then wipe off.
Accumulation of baked-on stains/dirt. Sugar spills, melted plastics.	Cleaning sponges Scraper for glass.	Thoroughly moisten the zone to be cleaned with hot water. Use a scraper for glass to remove the large bits, follow with the rough side of a disinfectant sponge, and then wipe off.
Rings and hard water residue.	White vinegar.	Apply warm white vinegar to the stain, let stand, then wipe with a soft cloth.
Shiny metal colourings. Weekly maintenance.	Special vitroceramic glass product.	Apply a cleaning agent for vitroceramic glass (preferable one with silicon for its protective properties) to the surface.



cream



cleaning sponge  
special for delicate crockery



powder



abrasive sponge

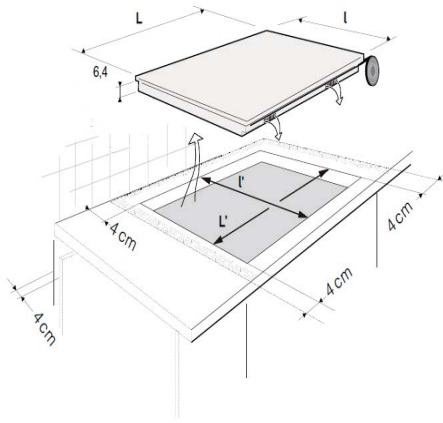

## Installation

Your appliance should be positioned so that the mains switch is accessible. The distance between the edge of your appliance and the side and rear walls (or partitions) must be at least four centimetres (area A).

Your appliance can be easily integrated above a cabinet, an oven or a build-in household appliance. Simply verify that the air intakes and outlets are free of obstruction, poor ventilation can affect both the performance of your appliance and reduce its lifespan.

Stick the foam gasket to the bottom of your appliance. This will allow you to achieve an airtight seal with the worktop.

Attach the clips to the hob if supplied.

## Cut-out Information.

Please ensure the correct cut out size for your appliance. Details of the cut out sizes are shown on page 4.

L' being the width (left to right)

l' the depth of the cut out (front to back)

## Installing above a cupboard

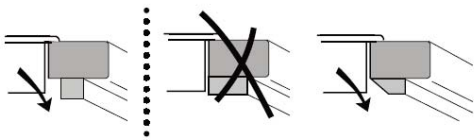
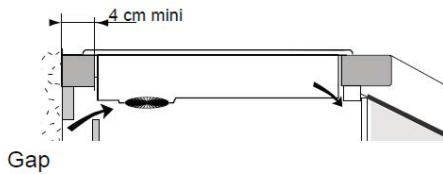

When installing above a cupboard please ensure a gap for ventilation is provided to the rear of the cupboard. You should also ensure that the ventilation slots in the front of the appliance are not blocked / obscured in any way.

It may be necessary to cut the work-surface or cupboard carcass to ensure adequate air flow.

## Installing above a drawer

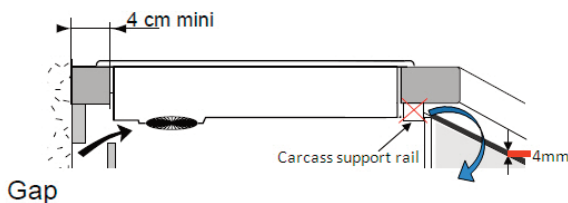

When installing your appliance above a drawer or shallow cupboard, it may be necessary to remove the carcass support rail from the housing in order to ensure a 4mm air gap is maintained.

## Installing above a oven

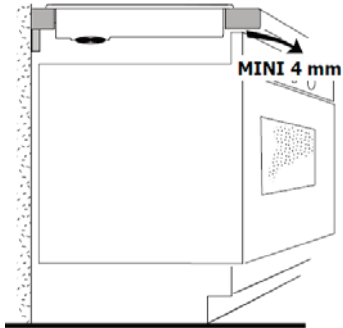

When installing your appliance above an oven, it may be necessary to remove the carcass support rail from the housing in order to ensure a 4mm air gap is maintained. Most modern ovens including all De Dietrich models will not require any further insulation between the oven and hob.

It is not recommended to use the Pyro-clean function of an oven while using the hob.



### Use of sealants

The appliance should be fixed to the work-surface using the roll of foam seal provided. Any appliance sealed to the work-surface using silicone sealant or similar may result in damage to both the appliance and work-surface should it need to be removed. The use of sealants may result in the appliance being unserviceable and as such may be excluded from warranty repairs.

## Electrical connection

Hook-up of 220-240V ~32 amp

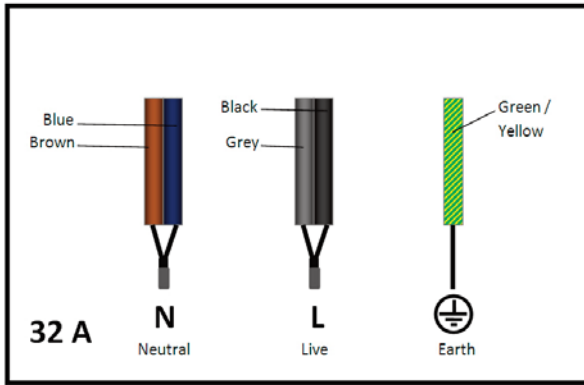

Hook-up of 220-240V ~16 amp

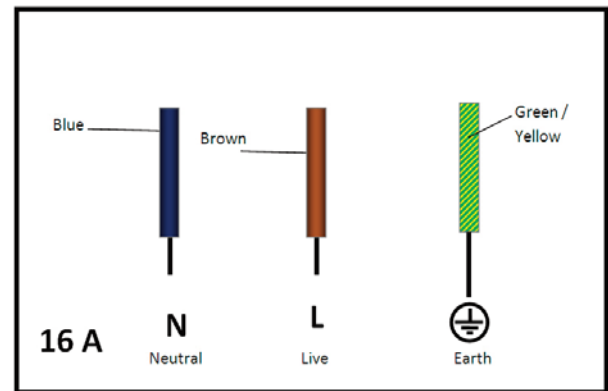

• Hook-up of 2x230V 2L+2N ~ - 16A

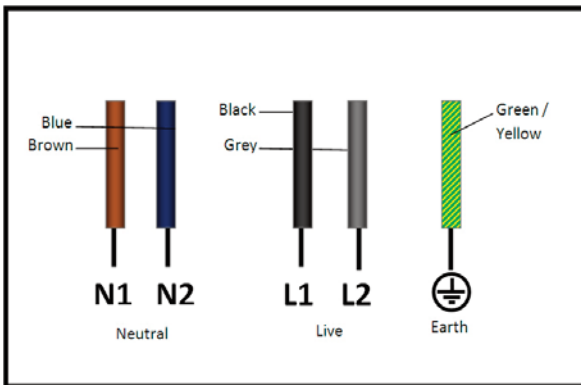

• Hook-up of 400V 2N ~ - 16A

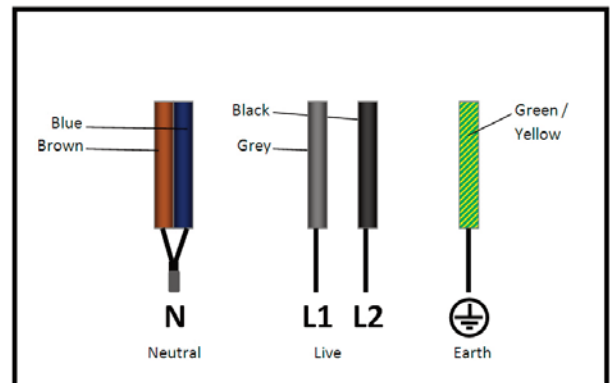

• Hook-up of 400V 3~ - 16A

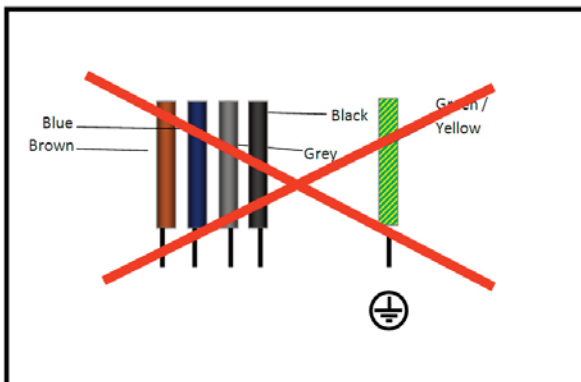



**Warning**  
 ⚠ If the cable is damaged it must be replaced by the manufacturer, its after-sales service or a person with a similar qualification to prevent danger.

During Installation

	<i>POSSIBLE CAUSES:</i>	<i>WHAT SHOULD YOU DO?</i>
A special lamp appears.	Working normally.	Nothing, the light disappears after 30 seconds.
Your installation blows a fuse.	The electrical connection of your hob is incorrect.	Check that it is set up properly. See the "Electrical Connection" section.
Only one side works.		
The hob produces an odour during the first cooking sessions.	New appliance.	Nothing. The smell will disappear after several uses.

While switching on

<i>YOU OBSERVE THAT:</i>	<i>POSSIBLE CAUSES:</i>	<i>WHAT SHOULD YOU DO?</i>
The hob does not operate and the indicator lights on the control panel do not light up.	The machine is not connected to the power source. The power source or connection is defective.	Inspect the electrical circuit breaker and fuses.
The hob is not working and another message is displayed.	The electronic board is functioning poorly.	Call the After-Sales Service Department.
The hob does not function, the information   is displayed.	The hob is locked	See chapter on using the child safety system

While in use

You Observe That	Possible Causes	What should you do?
The hob has stopped working and a “-“ or F7 is displayed	There was an overflow or an object in contact with the control panel	Clean the hob or remove the object then restart cooking again
A series of small “_” or F7 appear on the display	The electronic circuits have over heated	Please ensure the appliance is fitted in line with this guide paying particular attention to the ventilation requirements
After turning on a heating zone the indicator for the cooking zone continues to flash	The cookware used is not suitable for induction or is too small for the selected zone	Please see the section on cookware. A simple rule is if a magnet will stick to the pan it should be suitable.
The pans make a noise during cooking and the hob produces a clicking noise	It is normal for some types of cookware. This is caused by the transfer of energy from the hob to the cookware.	Nothing. There is no risk to either the hob or cookware.
The fan continues to operate after the hob is turned off	The fan is cooling the electronics and will cut out automatically.	Nothing
The hob cuts out during cooking	The electronics have detected a power surge and have cut out in order to protect the electronics.	Turning the appliance off at the mains and turning back on will reset the electronics. If the issue persists an engineer may need to be called.
The hob cuts out during cooking	The appliance has overheated the electronics	This may be the result of incorrect installation, please check the appliance has sufficient ventilation